

合肥中恒微半导体有限公司

HeFei Cpower Technology.,Ltd.

TLV150M07S1P



➤ 产品外观 / Appearance



$V_{CES} = 650V$

$I_{C\ nom} = 150A / I_{CRM} = 300A$

➤ 特性 / Features

- A. 低开关损耗
- B. 低饱和压降
- C. 高短路耐量

- A. Low Switching Losses
- B. Low $V_{CE(sat)}$
- C. High Short Circuit Capability (10us)

➤ 用途 / Applications

- A. 三电平应用
- B. 太阳能应用
- C. 不间断电源

- A. 3-Level-Applications
- B. SolarApplications
- C. UPS (Uninterruptible Power Supplies)

➤ 相关信息 / Related Information

条形码 / Barcode Code



二维码 / DMX – Code



公司地址：合肥市高新区创新大道与明珠大道交叉口 106 号 5 号楼 2 层 C 区、D 区。

Address: Area C and D, 2nd floor, Building 5, No. 106, Intersection of Innovation Avenue and Mingzhu Avenue, High-tech Zone, Hefei City.

TLV150M07S1P

IGBT, 逆变器 / IGBT, Inverter



最大额定值 / Maximum Rated Values

集电极-发射极电压 Collector-emitter voltage	$T_j = 25^\circ\text{C}$	V_{CES}	650V	V
连续集电极直流电流 Continuous DC collector current	$T_C = 100^\circ\text{C}, T_{j\max} = 175^\circ\text{C}$	$I_{C\text{ nom}}$	150	A
集电极重复峰值电流 Repetitive peak collector current	$t_p = 1\text{ ms}$	I_{CRM}	300	A
栅极-发射极峰值电压 Gate-emitter peak voltage		V_{GES}	+/-20	V
总功率损耗 Total power dissipation	$T_C = 25^\circ\text{C}, T_{j\max} = 175^\circ\text{C}$	P_{tot}	317	W

特征值 / Characteristic Values

		Min.	Typ.	Max.		
集电极-发射极饱和电压 Collector-emitter saturation voltage	$I_C = 150\text{A}, V_{GE} = 15\text{ V}$ $T_j = 25^\circ\text{C}$ $T_j = 125^\circ\text{C}$ $T_j = 150^\circ\text{C}$	$V_{CE\text{ sat}}$	1.6 1.75 1.8	1.80		V
栅极阈值电压 Gate threshold voltage	$I_C = 2\text{mA}, V_{CE} = V_{GE}, T_j = 25^\circ\text{C}$	$V_{G\text{ eth}}$	5.0	5.8	6.8	V
栅极电荷/Gate charge	$V_{GE} = -15\text{V} \dots +15\text{V}$	Q_G		1.20		μC
输入电容/Input capacitance	$f = 1\text{ MHz}, T_j = 25^\circ\text{C}, V_{CE} = 25\text{ V}, V_{GE} = 0\text{ V}$	C_{ies}		13.0		nF
反向传输电容 Reverse transfer capacitance		C_{res}		0.25		nF
集电极-发射极截止电流 Collector-emitter cut-off current	$V_{CE} = 650\text{ V}, V_{GE} = 0\text{ V}, T_j = 25^\circ\text{C}$	I_{CES}			1.0	mA
栅极-发射极漏电流 Gate-emitter leakage current	$V_{CE} = 0\text{ V}, V_{GE} = 20\text{ V}, T_j = 25^\circ\text{C}$	I_{GES}			500	nA
开通延迟时间/Turn-on delay time	$I_C = 150\text{ A}, V_{CE} = 300\text{ V}$ $V_{GE} = \pm 15\text{ V}$ $R_G = 3.3\ \Omega$ Inductive Load	$T_j = 25^\circ\text{C}$ $T_j = 125^\circ\text{C}$ $T_j = 150^\circ\text{C}$	$t_{d\text{ on}}$	216 226 230		ns
上升时间/Rise time		$T_j = 25^\circ\text{C}$ $T_j = 125^\circ\text{C}$ $T_j = 150^\circ\text{C}$	t_r	82 85 89		ns
关断延迟时间/Turn-off delay time		$T_j = 25^\circ\text{C}$ $T_j = 125^\circ\text{C}$ $T_j = 150^\circ\text{C}$	$t_{d\text{ off}}$	288 301 303		ns
下降时间/Fall time		$T_j = 25^\circ\text{C}$ $T_j = 125^\circ\text{C}$ $T_j = 150^\circ\text{C}$	t_f	140 245 250		ns
开通损耗能量/Turn-on energy loss		$T_j = 25^\circ\text{C}$ $T_j = 125^\circ\text{C}$ $T_j = 150^\circ\text{C}$	E_{on}	1.27 1.63 1.7		mJ
关断损耗能量/Turn-off energy loss		$T_{vj} = 25^\circ\text{C}$ $T_{vj} = 125^\circ\text{C}$ $T_j = 150^\circ\text{C}$	E_{off}	5.51 7.55 7.40		mJ
短路数据/SC data		$V_{GE} \leq 15\text{ V}, V_{CC} = 360\text{ V}$ $t_p \leq 6\ \mu\text{s}, T_j = 150^\circ\text{C}$	I_{sc}		650	
结 - 壳子热阻 Thermal resistance, junction to case	每个 IGBT / per IGBT	R_{thJC}			0.28	K/W
在开关状态下温度 Temperature under switching		$T_{j\text{ op}}$	-40		150	$^\circ\text{C}$

TLV150M07S1P

二极管, 逆变器 / Diode, Inverter



二极管, 逆变器 / Diode, Inverter

最大额定值 / Maximum Rated Values

反向重复峰值电压 Repetitive peak reverse voltage	$T_j = 25^\circ\text{C}$	V_{RRM}	650	V
连续正向直流电流 Continuous DC forward current	$t_p = 1\text{ ms}$	I_F	150	A
正向重复峰值电流 Repetitive peak forward current	$t_p = 1\text{ ms}$	I_{FRM}	300	A
I^2t -值 / I^2t -value	$V_R = 0\text{V}, t_p = 10\text{ms}, T_j = 125^\circ\text{C}$ $V_R = 0\text{V}, t_p = 10\text{ms}, T_j = 150^\circ\text{C}$	I^2t	1900 1650	A^2s

特征值 / Characteristic Values

			Min.	Typ.	Max.	
正向电压/Forward voltage	$I_F = 150\text{ A}, V_{GE} = 0\text{ V}$	$T_j = 25^\circ\text{C}$ $T_j = 125^\circ\text{C}$ $T_j = 150^\circ\text{C}$	V_F	1.60 1.74 1.75	2.00	V
反向恢复峰值电流 Peak reverse recovery current		$T_j = 25^\circ\text{C}$ $T_j = 125^\circ\text{C}$ $T_j = 150^\circ\text{C}$	I_{RM}	83 98 110		A
恢复电荷/Recovered charge	$I_F = 150\text{ A}, V_R = 300\text{ V}$ $V_{GE} = -15\text{ V}$ $-di_F/dt = 2200\text{ A}/\mu\text{s}$	$T_j = 25^\circ\text{C}$ $T_j = 125^\circ\text{C}$ $T_j = 150^\circ\text{C}$	Q_r	6 8.7 10.6		μC
反向恢复损耗 Reverse recovery energy		$T_j = 25^\circ\text{C}$ $T_j = 125^\circ\text{C}$ $T_j = 150^\circ\text{C}$	E_{rec}	1.4 2.1 2.5		mJ
结 - 壳子热阻 Thermal resistance, junction to case	每个二极管 / per diode		R_{thJC}		0.44	K/W
在开关状态下温度 Temperature under switching			$T_{j\text{op}}$	-40	150	$^\circ\text{C}$

TLV150M07S1P

二极管,D5-D6/ Diode,D5-D6

负温度系数热敏电阻 / NTC-Thermistor



二极管,D5-D6/ Diode,D5-D6

最大额定值 / Maximum Rated Values

反向重复峰值电压 Repetitive peak reverse voltage	$T_j = 25^\circ\text{C}$	V_{RRM}	650	V
连续正向直流电流 Continuous DC forward current		I_F	150	A
正向重复峰值电流 Repetitive peak forward current	$t_p = 1\text{ ms}$	I_{FRM}	300	A
I^2t -值 / I^2t - value	$V_R = 0\text{V}, t_p = 10\text{ms}, T_j = 125^\circ\text{C}$	I^2t	1900	A^2s
	$V_R = 0\text{V}, t_p = 10\text{ms}, T_j = 150^\circ\text{C}$		1650	

特征值 / Characteristic Values

		Min.	Typ.	Max.	
正向电压/Forward voltage	$I_F = 15\text{ A}, V_{GE} = 0\text{ V}$	$T_j = 25^\circ\text{C}$ $T_j = 125^\circ\text{C}$ $T_j = 150^\circ\text{C}$	V_F	1.60 1.74 1.75	V
反向恢复峰值电流 Peak reverse recovery current		$T_j = 25^\circ\text{C}$ $T_j = 125^\circ\text{C}$ $T_j = 150^\circ\text{C}$	I_{RM}	83 98 110	A
恢复电荷/Recovered charge	$I_F = 150\text{A}, V_R = 300\text{ V}$ $V_{GE} = -15\text{ V}$ $-di_F/dt = 2200\text{A}/\mu\text{s}$	$T_j = 25^\circ\text{C}$ $T_j = 125^\circ\text{C}$ $T_j = 150^\circ\text{C}$	Q_r	6 8.7 10.6	μC
反向恢复损耗 Reverse recovery energy		$T_j = 25^\circ\text{C}$ $T_j = 125^\circ\text{C}$ $T_j = 150^\circ\text{C}$	E_{rec}	1.4 2.1 2.5	mJ
结 - 壳子热阻 Thermal resistance, junction to case	每个二极管 / per diode		R_{thJC}		0.44 K/W
在开关状态下温度 Temperature under switching			$T_{j\text{ op}}$	-40	150 $^\circ\text{C}$

负温度系数热敏电阻 / NTC-Thermistor

特征值 / Characteristic Values

		Min.	Typ.	Max.	
额定阻值/Rated resistance	$T_C = 25^\circ\text{C}$	R_{25}	5.00		k Ω
阻值误差/Deviation of R100	$T_C = 100^\circ\text{C}, R_{100} = 493.3\ \Omega$	$\Delta R/R$	-5	5	%
功率损耗/Power dissipation	$T_C = 25^\circ\text{C}$	P_{25}		20.0	mW
B 值/B - value	$R_2 = R_{25} \exp [B_{25/50}(1/T_2 - 1/(298.15\text{K}))]$	$B_{25/50}$	3375		K
B 值/B - value	$R_2 = R_{25} \exp [B_{25/80}(1/T_2 - 1/(298.15\text{K}))]$	$B_{25/80}$	3411		K
B 值/B - value	$R_2 = R_{25} \exp [B_{25/100}(1/T_2 - 1/(298.15\text{K}))]$	$B_{25/100}$	3433		K

TLV150M07S1P

模块 / Module



绝缘测试电压 Isolation test voltage	RMS, f = 50 Hz, t = 1 min.	V _{ISOL}	2.5	kV
内部绝缘/Internal isolation	基本绝缘 (class 1, IEC61140) Basic insulation (class 1, IEC61140)		Al ₂ O ₃	
爬电距离/Creepage distance	端子至散热器 / terminal to heatsink 端子至端子 / terminal to terminal		11.5 6.3	mm
电气间隙/Clearance	端子至散热器 / terminal to heatsink 端子至端子 / terminal to terminal		10.0 5.0	mm
相对电痕指数 Comperative tracking index		CTI	> 200	

			Min.	Typ.	Max.	
杂散电感, 模块 Stray inductance module		L _{SCE}		15		nH
模块引线电阻 Module lead resistance	T _c = 25°C, 每个开关 / per switch	R _{CC'+EE}		2.00		mΩ
储存温度/Storage temperature		T _{stg}	-40		125	°C
每夹具安装力 Mounting force per clamp		F	40		80	N
重量/Weight		G		40		g

TLV150M07S1P

封装 / Package



接线图 / Circuit Diagram

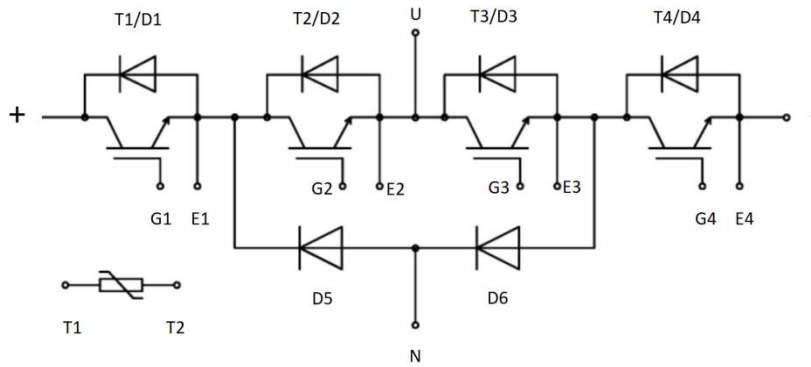

封装尺寸 / Package outlines

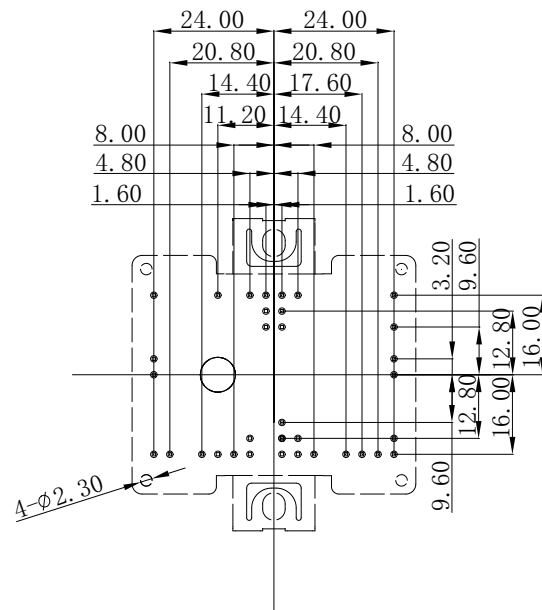
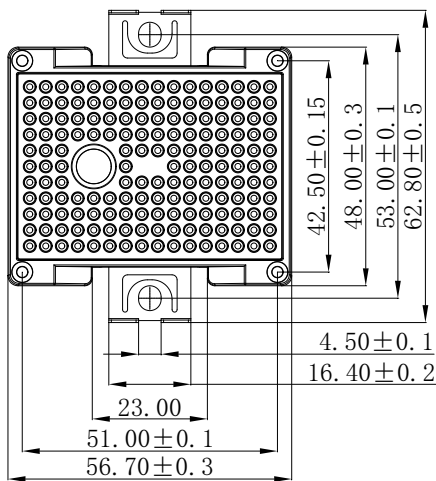
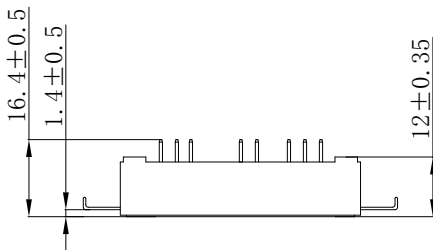

TLV150M07S1P

性能 / Performance



输出特性 IGBT, 逆变器 (典型)
output characteristic IGBT, Inverter (typical)

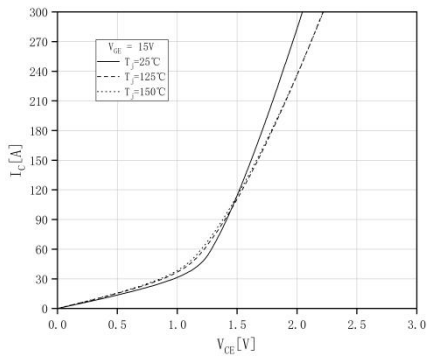

输出特性 IGBT, 逆变器 (典型)
output characteristic IGBT, Inverter (typical)

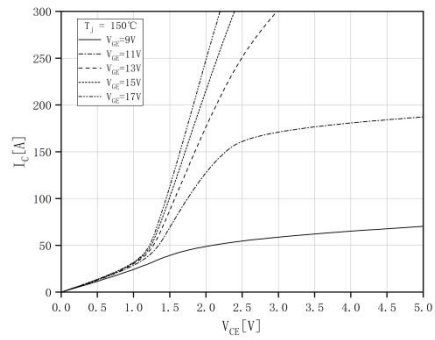

开关损耗 IGBT, 逆变器 (典型)
switching losses IGBT, Inverter (typical)

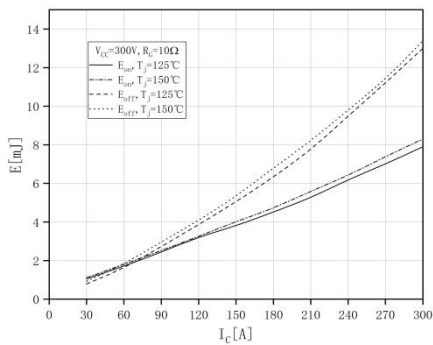

开关损耗 IGBT, 逆变器 (典型)
switching losses IGBT, Inverter (typical)

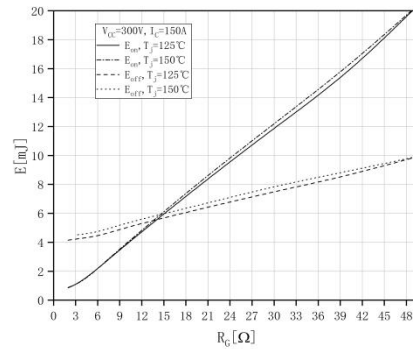

瞬态热阻抗 IGBT, 逆变器
transient thermal impedance IGBT, Inverter

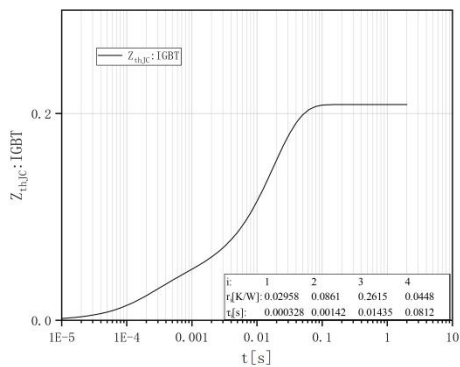

反偏安全工作区 IGBT, 逆变器 (RBSOA)
Reverse bias safe operating area IGBT, Inverter(RBSOA)

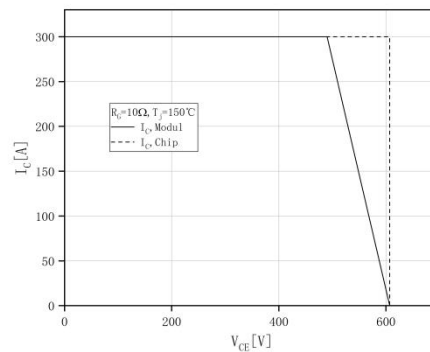

TLV150M07S1P

性能 / Performance



正向偏压特性 二极管,逆变器 (典型)
forward characteristic of Diode, Inverter(typical)

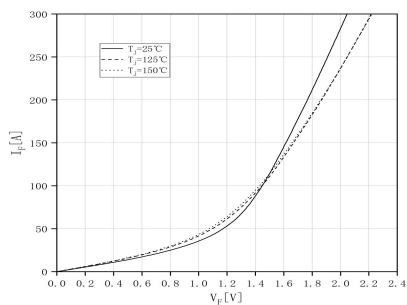

开关损耗 二极管, 逆变器 (典型)
switching losses Diode, Inverter(typical)

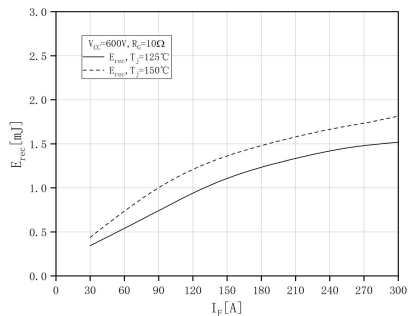

开关损耗 二极管, 逆变器 (典型)
switching losses Diode, Inverter(typical)

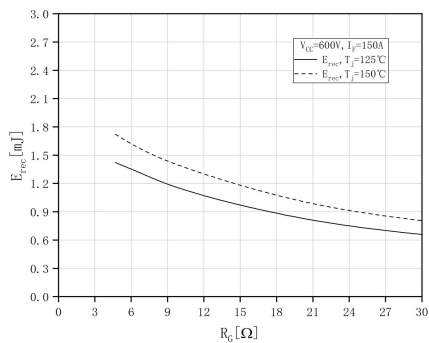

瞬态热阻抗 二极管, 逆变器
transient thermal impedance Diode, Inverter

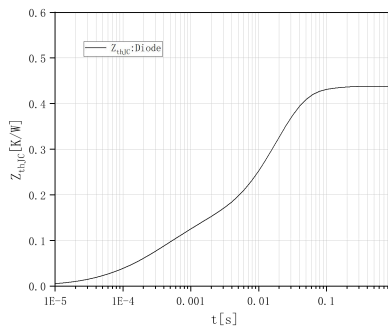

正向偏压特性 二极管,D5-D6(典型)
forward characteristic of Diode, D5-D6(typical)

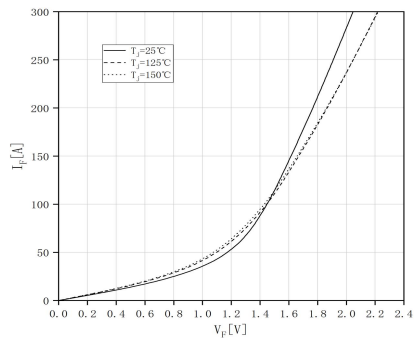

开关损耗 二极管,D5-D6 (典型)
switching losses Diode, D5-D6(typical)

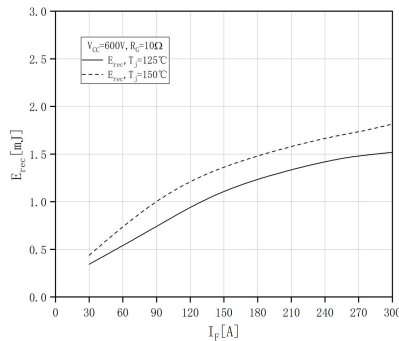

开关损耗 二极管, D5-D6 (典型)
switching losses Diode, D5-D6(typical)

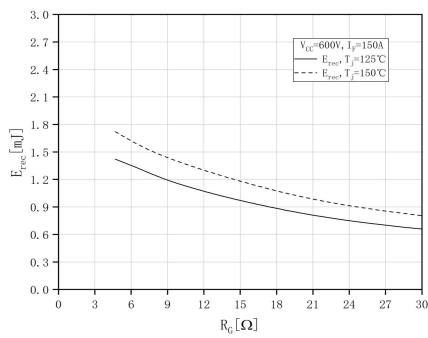

瞬态热阻抗 二极管, D5-D6
transient thermal impedance Diode, D5-D6

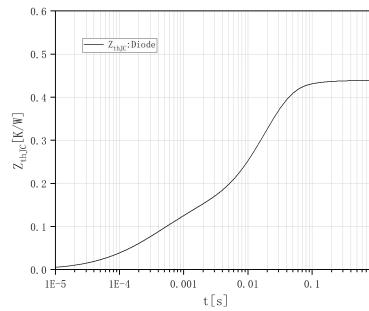

负温度系数热敏电阻温度特性 (典型)
NTC-Thermister-temperature characterister(typical)

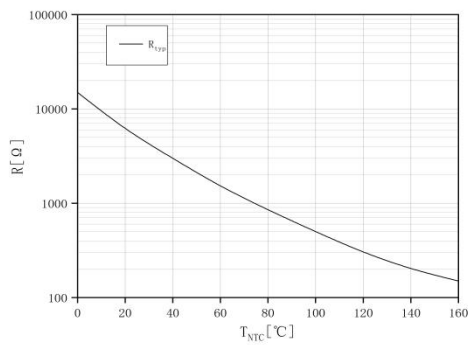

TLV150M07S1P

使用条件及条款

Terms & Conditions of usage



本档所提供的任何信息绝不应被视为针对任何条件或者品质而做出的保证（质量保证）。本公司对于本档中所提及的任何事例、提示或者任何特定数值及/或任何关于产品应用方面的信息均在此明确声明本公司不承担任何保证或者责任，包括但不限于其不侵犯任何第三方知识产权的保证均在此排除。

此外，本档所提供的任何信息均取决于客户履行本档所载明的义务和客户遵守适用于客户产品以及与客户对于本公司产品的应用所相关的任何法律要求、规范和标准。

本档所含的数据仅供经过专业技术培训的人员使用。客户自身的技术部门有义务对于产品是否适宜于其预期的应用和针对该种应用而言本档中所提供的信息是否充分自行予以评估。

如需产品、技术、交付条款和条件以及价格等进一步信息，请向本公司接洽。

The information given in this document shall in no event be regarded as a guarantee of conditions or characteristics("quality guarantee"). With respect to any examples, hints or any typical values stated herein and/or any information regarding the application of the product, Cpower Technology hereby disclaims any and all warranties and liabilities of any kind, including without limitation warranties of non-infringement of intellectual property rights of any third party.

In addition, any information given in this document is subject to customer's compliance with its obligations stated in this document and any applicable legal requirements, norms and standards concerning customer's products and any use of the product of Cpower Technology in customer's applications.

The data contained in this document is exclusively intended for technically trained staff. It is the responsibility of customer's technical departments to evaluate the suitability of the product for the intended application and the completeness of the product information given in this document with respect to such application.

For further information on the product, technology, delivery terms and conditions and prices please contact Cpower Technology.